

STT 3000 Series STT250

Smart Temperature Transmitters Specifications

Models STT25H, STT25S, STT25M, STT25D

EN01-6031 March 2010 Rev.1



Introduction

Honeywell's STT 3000 family of microprocessor based smart temperature transmitters includes both the Series STT250 described in this specification sheet and the higher performance STT350 described in Product Specification Sheet EN01-5222. The STT350 offers high performance and advanced functionality. The STT250 units offer competitive performance in a more compact module and with a wider range of smart communications protocols.

- STT25H with HART™ protocol when this popular protocol is preferred. Configuration of the HART unit can be made with any of the listed HART Communication Foundation tools.
- STT25S with HART 6 protocol and TUV SIL 2 approval. Configuration of the HART unit can be made with any of the listed HART tools
- STT25M for 4-20mA operation and local/ remote configuration via Honeywell's digital DE protocol from the Smart Field Communicator (SFC) or Smart Configuration Toolkit PC based software (SCT).
- STT25D with digital DE protocol for either 4-20mA operation or digital integration into the TDC 3000™/ TPS 3000™ control system.

Note that the latest addition to the STT250 family is the Dual Input **STT25T**. The two sensor inputs may be used for sensor cross checking or for TC sensor redundancy. This is described in separate Product Specification Sheet EN01-6091.

All units support the same wide range of primary sensor types, are 2 wire powered and give an output linearized to temperature over the 2 power wires. Lead wire compensation is provided for RTD (Resistance Temperature Detectors) and internal digital cold junction compensation is provided for Thermocouples, Millivolt and Ohms sensor inputs can also be accepted.

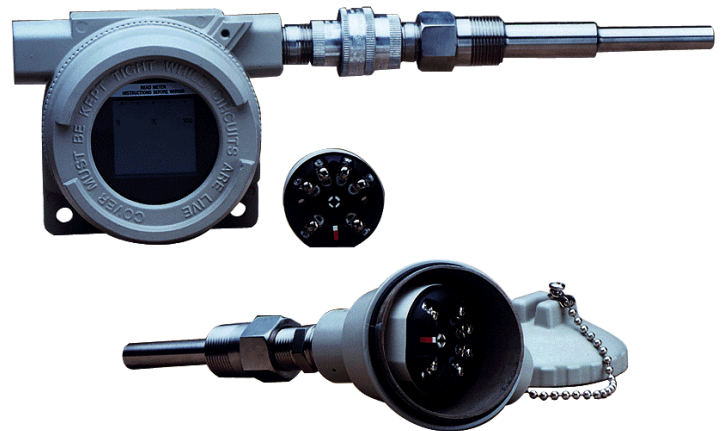

Features

- Smart communication protocols available include HART or DE Honeywell.
- Direct sensor head mounting in DIN Form A housing. Housing materials available include plastic, aluminum, 316SS and cast iron.
- Mounting options include wall, pipe, DIN rail or direct sensor head mounting with or without a housing.
- Single model accepts input signal from a wide choice of primary sensors to satisfy varying application requirements with minimum transmitter inventory.
- Suitable for 4, 3 or 2 wire Pt100 and Pt200 RTD measurement.
- Hard wired upscale/ downscale failsafe link to ensure secure operation in the event of a failure.
- Open circuit sensor analysis carried out in every measurement cycle.
- Selectable latching/non-latching failsafe operation for open circuit sensor.
- Integral analogue or digital indication meter option.
- Analogue to Digital converter validated frequently

Description

The STT250 transmitters are suitable as replacements for any conventional or most smart temperature transmitters in use today. The memory contains the characteristics of most commonly used temperature sensors.

You can easily use the hand held communicator or PC tool to configure the transmitter for any of these sensors and it will automatically correct for their associated non-linearity's.

Accuracies stated below are available merely by selecting the sensor type and range (i.e. without user calibration).

Calibration of the LRV/URV end points will typically give accuracy improvements of 2 times. Sensor errors can be calibrated out by calibration to the specific sensor either by having it at the LRV/URV temperatures or by simulation of the known values.

In addition, all units pass through Environmental Stress Screening by fast cycling between -40°C and +85°C to ensure maximum product reliability. During this process the ambient temperature coefficients are determined for each unit and burned into memory to ensure temperature compensation over a wide range of operating conditions.

Configuration adjustments and diagnostics checks can be made either locally or remotely over the signal wires from anywhere along their route. This enables major savings in manpower time during commissioning, start up and maintenance activities.

Performance Under Rated Conditions

Sensor	Digital Accuracy over Normal Range		D/A Accuracy % of span	Digital Accuracy over Maximum Range		Standards
	°C	(°F)		°C	(°F)	
Pt100	0.15C for -200 to 450	(-328 to 842)	0.025%	0.25C for -200 to 850C	(-328 to 1562)	IEC751(ITS-90)($\alpha=0.00385$)
Pt200	0.30C for -200 to 450	(-328 to 842)	0.025%	0.40C for -200 to 850C	(-328 to 1562)	IEC751(ITS-90)($\alpha=0.00385$)
Pt100J	0.15C for -200 to 450	(-328 to 842)	0.025%	0.25C for -200 to 640C	(-328 to 1184)	JISC1604-81($\alpha=0.00392$)
Ω	0.40Ω for 0 to 1000Ω		0.025%	0.40Ω for 0 to 2,000Ω *		
mV	15μV for -20 to 120mV		0.025%	15μV for -20 to 120mV		
B	1.0C for 550 to 1820	(1022 to 3308)	0.025%	3.0C for 200 to 1,820C	(392 to 3308)	IEC 584-1(ITS-90)
E	0.30C for 0 to 1000	(32 to 1832)	0.025%	0.60C for -200 to 1,000C	(-328 to 1832)	IEC 584-1(ITS-90)
J	0.30C for 0 to 800	(32 to 1472)	0.025%	0.70C for -200 to 1,200C	(-328 to 2192)	IEC 584-1(ITS-90)
K	0.60C for -120 to 1370	(-191 to 2498)	0.025%	0.90C for -200 to 1370C	(-328 to 2498)	IEC 584-1(ITS-90)
N	0.40C for 0 to 1300	(32 to 2372)	0.025%	1.5C for -200 to 1300C	(-328 to 2372)	IEC 584-1(ITS-90)
R	0.60C for 500 to 1760	(932 to 3200)	0.025%	1.0C for -50 to 1760C	(-58 to 3200)	IEC 584-1(ITS-90)
S	0.60C for 500 to 1760	(932 to 3200)	0.025%	1.0C for -50 to 1760C	(-58 to 3200)	IEC 584-1(ITS-90)
T	0.30C for -100 to 400	(-148 to 752)	0.025%	0.5C for -250 to 400C	(-418 to 752)	IEC 584-1(ITS-90)

* * 4 wire ohms input only and limited to 0 to 1,000 Ohms for model STT25D

Specifications

Operation Conditions

Parameter	Reference Condition	Rated Condition	Operative Limits	Transportation And Storage
Ambient temperature °C	23 °C ± 2	-40 to +85	-40 to +85	-50 to +100
Humidity				
Rack mounted % RH	10 to 55	5 to 95	5 to 100	5 to 100
In field housing % RH	10 to 55	5 to 100	5 to 100	5 to 100
Supply voltage	Voltage range 10.8 to 35 Vdc at the transmitter terminals			
Output current - standard	Over linear range 3.8 to 20.8 mA. Failsafe limits < 3.8 and 21.1 mA			
Output current – NAMUR NE43	Over linear range 3.8 to 20.5 mA. Failsafe limits < 3.6 and 21.1 mA			
Load resistance	0 to 1110Ω			
Vibration	Maximum of 4g over 15 to 200Hz (restricted to 3g with indication meter).			
Shock	Maximum of 40g.			

Performance Specifications

Output D/A accuracy: ±0.025% of span

Cold Junction accuracy: ±0.5°C

Total reference accuracy: Analogue 4-20mA mode = Digital accuracy + Output D/A accuracy + CJ accuracy (T/Cs only)

Total reference accuracy: Digital DE mode = Digital accuracy + CJ accuracy (T/Cs only).

(example: transmitter operating in analogue mode with Pt100 sensor and 0 to 200°C range.

Total reference accuracy =
 $0.15 + (200/100) * 0.025 = 0.2\%$

Digital ambient temperature effect (per 10°C change from 23°C ref.): RTDs or Ohms : 0.050% of reading in Ohms. : T/Cs or mV : 0.080% of reading in mV.

Output D/A ambient temp. effect (per 10°C change from 23°C ref.): ±0.045% of span.

Cold Junction ambient temperature effect: 40: 1 rejection for ambient temperature changes from 23°C reference.

Total Reference Accuracy (Reference – Includes combined effects of linearity, hysteresis, and repeatability)

Total output ambient temperature effect : Analogue 4-20mA mode = Digital effect + Output D/A effect + CJ effect (T/Cs only).

Total output ambient temperature effect: Digital DE mA mode = Digital effect + CJ effect (T/Cs only).

Power supply voltage effect: 0.005% of Max span per Volt.

Stability/time drift: 0.05% of max span per year.

Additional Parameters

Output: 4-20mA or Honeywell digital DE protocol. HART and DE available with 4-20mA output.

Adjustment range: No limits to adjustments within the Maximum Range except minimum span limit of 1 engineering unit e.g. 1°C

Damping time constant: Adjustable from 0 to 102 seconds digital damping.

Output response time: 1 second to reach 63% of final value with 0 secs damping.

Output update time 0.5 secs approximately.

Input/ output galvanic isolation
Withstands 500Vac dielectric strength test for 1 minute.

Sensor open circuit
Open circuit/ burnout detection is user selectable. Upscale or downscale with critical status message. Latching or non-latching sensor burnout action.

Common mode rejection
120dB (1 million to 1) from 50Hz to 50 kHz.

Series mode rejection
40dB (100 to 1) for 50 or 60Hz ±0.5Hz. (with internal software filter set to local power line frequency).

EMC compliance
In compliance with 2004/108/EC, Electromagnetic Compatibility (EMC) Directive.

Radiated RF Immunity: ±0.15% of span at 10V/m over 80 to 1,000MHz.

Physical Mounting and Construction

The STT250 Temperature Transmitter is designed to be mounted in a DIN Form A housing for direct installation with the temperature sensor or can be provided in a remote pipe or wall mount housing. Details for the various housings available are referenced in the table below. The STT250 Temperature Transmitter module can also be DIN rail mounted to a top hat or “G” rail via a clip. Integral meters available

Integral Meters

Honeywell’s Series STT250 Temperature Transmitters can be supplied with local or remote indication. An Analogue, Engineering Units or a Smart meter can be mounted integral to the transmitter inside the field mount housing. Order an integral meter as part of the model number; Table II __ M, __ E and __ S, respectively. Order a remote meter as model RMA300. The analogue meter is a 4-20mA moving coil type and displays the temperature in 0 to 100% span.

The E. U. meter displays temperature in engineering units with the STT25H, STT25T and STT25S HART units. Refer to 34-ST-25-08D for more details. The Smart meter accepts 4-20mA or DE protocol and displays temperature on a LCD in engineering units or 0 to 100% span.

The remote digital meter reads DE protocol and displays temperature on a LCD in 0 to 100% span. Refer to 34-ST-25-07A for details.

STT250 Module Dimensions (in/mm)

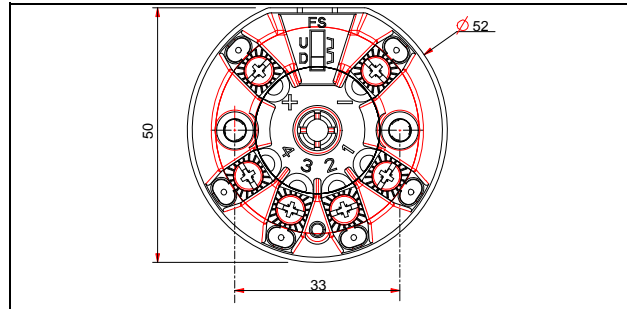
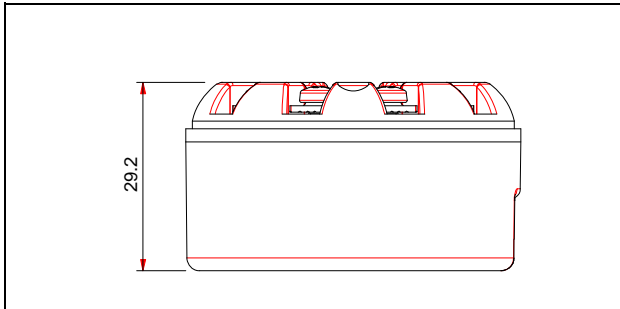

STT250 Connections

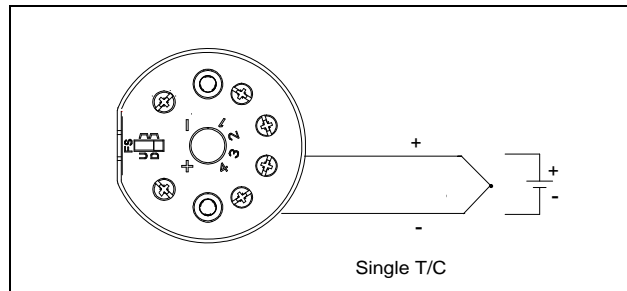
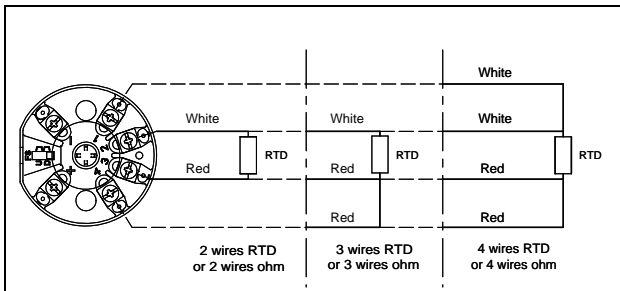

Materials of Construction

- | | |
|-------------------|--|
| Terminal Block | Noryl |
| Connection Screws | M3 Nickel plated brass |
| Module Housing | Cycloy (PC/ABS) with metallized interior surface |
| Weight | 0.075 kg (0.2 lbs) |

Approvals

The STT250 Temperature Transmitter module is Intrinsically Safe to ATEX, IECEx , SAEx, FM and CSA standards when used with a suitable safety barrier. It is zone 2 and explosion-proof to ATEX, IECEx, SAEx, FM and CSA standards when installed in a suitable housing. See the Model Selection Guide Table VII in this Specification Sheet for detailed safety approvals covering both the STT250 module only or for the STT250 module supplied in a housing

Probe and Thermo well Availability

STT250 can be supplied complete with a wide range of thermo wells, thermocouples or RTD sensors. See documents listed in the table below.

STT820 Series	34-44-16-08	Rigid Probe Assemblies.
STT830 Series	34-44-16-09	Threaded and Socket Weld Thermo well Assemblies with Transmitter Option.
STT840 Series	34-44-16-10	Drilled Flange Thermo well Assemblies

Sales and Service

For application assistance, current specifications, pricing, or name of the nearest Authorized Distributor, contact one of the offices below.

ASIA PACIFIC

(TAC)

hfs-tac-support@honeywell.com

Australia

Honeywell Limited
Phone: +(61) 7-3846 1255
FAX: +(61) 7-3840 6481
Toll Free 1300-36-39-36
Toll Free Fax:
1300-36-04-70

China – PRC - Shanghai

Honeywell China Inc.
Phone: (86-21) 5257-4568
Fax: (86-21) 6237-2826

Singapore

Honeywell Pte Ltd.
Phone: +(65) 6580 3278
Fax: +(65) 6445-3033

South Korea

Honeywell Korea Co Ltd
Phone: +(822) 799 6114
Fax: +(822) 792 9015

EMEA

Honeywell Process Solutions,
Phone: + 80012026455 or +44
(0)1202645583
FAX: +44 (0) 1344 655554

Email: (Sales)

sc-cp-apps-salespa62@honeywell.com

or

(TAC)
hfs-tac-support@honeywell.com

NORTH AMERICA

Honeywell Process Solutions,
Phone: 1-800-423-9883
Or 1-800-343-0228

Email: (Sales)

ask-ssc@honeywell.com

or

(TAC)
hfs-tac-support@honeywell.com

SOUTH AMERICA

Honeywell do Brasil & Cia
Phone: +(55-11) 7266-1900
FAX: +(55-11) 7266-1905

Email: (Sales)

ask-ssc@honeywell.com

or

(TAC)
hfs-tac-support@honeywell.com

Specifications are subject to change without notice.

Model Selection Guides are subject to change and are inserted into the specifications as guidance only. Prior to specifying or ordering a model check for the latest revision Model Selection Guides which are published with the corresponding product at www.honeywellprocess.com/

Model Selection Guide

Honeywell

STT 3000 Temperature Transmitter Series STT250



Model Selection Guide
34-44-16-03 Issue 35

Instructions

- Choose availability column based on mounting configuration.
- A dot (•) denotes unrestricted availability. A letter denotes restricted availability.
- Blank denotes unavailable - choose alternate mounting. Restrictions follow Table VII.
- Select the desired Key Number based on the desired communications protocol.
- Select options and approvals from Tables.

Key Number	I	II	III	IV	V	VI	VII
STT25_	-	-	-	-	-	-	-

HOW WILL THE UNIT BE MOUNTED?

Module only (no housing), to be DIN rail or wall mounted
 Module to be "head mounted" directly to the sensor in smaller housing
 Module to be "field mounted" in Explosion-Proof housing remotely from or directly to the sensor

Key Number

Description	Selection	Availability		
Smart Temperature Transmitter Module				
4-20mA Output, SFC/SCT Configurable	STT25M	•	•	•
HART 5, Protocol, 4-20mA Output	STT25H	•	•	•
HART 6, Protocol, 4-20mA Output	STT25S	•	•	•
Digital DE/ 4-20mA Output, for Digital Integration	STT25D	•	•	•
Dual input, HART Protocol, 4-20mA output	STT25T	•	•	•
All modules carry the following approvals: CE Mark for compliance to EN 50081-2 and 50082-2 Russian Certificate of Pattern Approval No. 2064 of Jan. 1998 Choose additional safety approvals required in Table VII				

TABLE I - Sensor, Probe and Thermowell Accessories

No Integral Sensor Probe or Thermowell Supplied	0	•	•	•
---	---	---	---	---

TABLE II - Transmitter Housing and Integral Meters (Reference EN01-6032 for details)

	Description	Selection	Availability		
Housing	No Housing Supplied	0__			•
	Field : Explosion-Proof Aluminum with Beige Epoxy Coating	E__	•		
	Mount (2): Explosion-Proof 316 Stainless Steel	T__	•		
	Head Mt :Type 4X housing - Beige	C__		•	
Cable/ Conduit Entry	Not Applicable - No Housing Supplied	_0_			•
	1/2" NPT Cable/ Conduit Entry	_N_	•	•	
	M20 x 1.5 Cable/ Conduit Entry	_M_		•	
Integral Meter	No Integral Meter Supplied	__0	•	•	•
	Analog Meter for Field Mount Housing	__M	•		
	E.U. Meter for Field Mount Housing	__E	h		
	Smart Meter for Field Mount Housing (3)	__S	i		

⁽²⁾ With a Field Mount Housing, 20 characters max. of customer information is available on the nameplate at no charge. (See 13:STT-OE pages for ordering instructions.)

⁽³⁾ For the STT25D and STT25M transmitters

HOW WILL THE UNIT BE MOUNTED?**Availability**

Module only (no housing), to be DIN rail or wall mounted

Module to be "head mounted" directly to the sensor in smaller housing

Module to be "field mounted" in Explosion-Proof housing remotely from or directly to the sensor

TABLE III - Configuration, Tagging and Manual

		Selection			
Configuration	None - Factory Default Configuration Supplied	0 __	•	•	•
	Transmitter Configuration (See 13:STT-OE pages for choice)	T __	•	•	•
Customer Tagging (4)	No Tagging Required	_ 0 _	•	•	•
	316 SS Wired-on Customer I.D. Tag (4 lines, 28 chars. per line, customer specified information)	_ T _	•	•	
	316 SS Wired-on Customer I.D. Tag (blank)	_ B _	•	•	
Operator's Manual (5)	None	__ 0	•	•	•
	English Language Version	__ E	•	•	•
	French Language Version	__ F	•	•	•
	Spanish Language Version	__ S	b	b	b
	Chinese Language Version	__ C	b	b	b

TABLE IV - Optional Equipment

Mounting Arrangement	No Mounting Arrangement Supplied	0 __	•	•	•
	Carbon Steel Mounting Bracket for 2" Pipe	M __	•		
	Stainless Steel Mounting Bracket for 2" Pipe	S __	•		
	Spring Loading Mounting set	L __		•	•
	DIN Rail Mounting via Clip (to Top Hat or "G" Rail)	D __			•
316 SS Conduit Adaptor for Wiring Entry	No Adaptor(s) Supplied	_ 0 _	•	•	•
	1/2" NPT to M20 x 1.5 : 1 Adaptor	_ 1 _	•	•	
	(EEx d IIC approved) : 2 Adaptors	_ 2 _	•	•	
	1/2" NPT to 3/4" NPT : 1 Adaptor	_ 3 _	•		
Lightning Protection	No Lightning Protection Supplied	__ 0	•	•	•
	Externally Mountable to Field Mount Housing	__ L	e		
	Internal Surge/ Lightning Protection	__ S	•		

TABLE V - Optional Extended Warranty Coverage & Certificates

Optional Extended Warranty	Standard Warranty	0 __	•	•	•
	Additional Warranty - 1 year	1 __	•	•	•
	Additional Warranty - 2 years	2 __	•	•	•
	Additional Warranty - 3 years	3 __	•	•	•
Optional Certificate (5)	No Transmitter Configuration/ Calibration Certificate	_ 0 _	•	•	•
	Transmitter Configuration/ Calibration Certificate	_ D _	•	•	•
	No Certificate of Conformance/ Origin	__ 0	•	•	•
	Certificate of Conformance/ Origin	__ C	•	•	•

TABLE VI - Additional Features

SIL2	No SIL2 - TUV Certified Transmitter	00	•	•	•
	SIL2 - TUV Certified Transmitter (requires HART 6)	S2	d	d	d

(4) Full model number does not appear on module or head mount housing.
If model number is to appear on unit, order wired on tag.

(5) Chosen Operator's Manuals and chosen Certificates are automatically shipped with unit.
See 13:STT-OE pages for additional manuals and alternate shipping.

HOW WILL THE UNIT BE MOUNTED?

Availability

Module only (no housing), to be DIN rail or wall mounted

Module to be "head mounted" directly to the sensor in smaller housing











Module to be "field mounted" in Explosion-Proof housing remotely from or directly to the sensor

TABLE VII - Safety Approvals (6)

Approval Body	Approval Type	Location or Classification	Selection			
None	No approval body certifications included		00	•	•	•
Factory Mutual	Explosion-Proof	Class I, Div. 1, Groups A,B,C,D	1C	f		
	Dust Ignition-Proof	Class II, III Div. 1, Groups E,F,G				
	Intrinsically Safe	Class I, II, III, Div. 1, Groups A,B,C,D,E,F,G				
	Non-Incendive	Class I, Div. 2, Groups A,B,C,D Suitable for Class II, III, Div. 2, Groups F, G				
	Outdoor Location	Enclosure Rated NEMA 4X				
	Explosion-Proof	Class I, Div. 1, Groups B,C,D	1J	•		
	Dust Ignition-Proof	Class II, III, Div. 1 Groups E,F,G				
	Intrinsically Safe	Class I, II, III, Div. 1, Groups A,B,C,D,E,F,G				
	Non-Incendive	Class I, Div. 2, Groups A,B,C,D Suitable for Class II, III, Div. 2, Groups F, G				
	Outdoor Location	Enclosure Rated NEMA 4X				
	Intrinsically Safe	Class I, II, III, Div. 1, Groups A,B,C,D,E,F,G	1G	•		
	Non-Incendive	Class I, Div. 2, Groups A,B,C,D Suitable for Class II, III, Div. 2, Groups F, G				
Outdoor Location	Enclosure Rated NEMA 4X					
CSA	Intrinsically Safe	Class I, Div. 1, Groups A,B,C,D	1G		•	•
	Non-Incendive	Class I, Div. 2, Groups A,B,C,D				
	Explosion-Proof	Class I, Div. 1, Groups B,C,D	2J	•		
	Dust Ignition-Proof	Class II, III, Div. 1, Groups E,F,G				
	Intrinsically Safe	Class I, II, III, Div. 1, Groups A,B,C,D,E,F,G				
	Non-Incendive	Class I, Div. 2, Groups A,B,C,D Suitable for Class II, III, Div. 2, Groups F, G				
	Outdoor Location	Enclosure Rated Type 4X	2G	•		
	Intrinsically Safe	Class I, II, III, Div. 1, Groups A,B,C,D,E,F,G				
Non-Incendive	Class I, Div. 2, Groups A,B,C,D Suitable for Class II, III, Div. 2, Groups F, G					
Outdoor Location	Enclosure Rated Type 4X	2G		•	•	
Intrinsically Safe	Class I, Div. 1, Groups A,B,C,D					
Non-Incendive	Class I, Div. 2, Groups A,B,C,D					

continued next page

TABLE VII - Safety Approvals (6) Continued

Approval Body	Approval Type	Location or Classification	Selection			
ATEX*	Intrinsically Safe Zone 0/1	 Ex ia IIC T6 (Ta = -50°C to +40°C) T5 (Ta = -50°C to +55°C) T4 (Ta = -50°C to +85°C) (Module)	3S	•	•	•
	Flameproof, Zone 1	 Ex d IIC T6 (Ta = -50°C to +80°C) T5 (Ta = -50°C to +85°C) Ex tD A21 T80°C (Ta = 80°C) T95°C (Ta = 85°C) Enclosure rated IP 66/67	3D	p		
	Non-Sparking Zone 2	 Ex nA, IIC T6*	3N	•	•	•
	Multiple Marking** Int. Safe, Zone 0/1, or Flameproof, Zone 1, or Non-Sparking, Zone 2	 Ex ia IIC T6 (Ta = -50°C to +40°C) T5 (Ta = -50°C to +55°C) T4 (Ta = -50°C to +85°C) -----  Ex d IIC T6 (Ta = -50°C to +80°C) T5 (Ta = -50°C to +85°C) Ex tD A21 T80°C (Ta = 80°C) T95°C (Ta = 85°C) -----  Ex nA, IIC T6 (Ta = -50°C to +85°C) (Honeywell) Enclosure Rated IP 66/67	3H	p		
SAEx (South Africa)	Intrinsically Safe Zone 0/1	SAEx S/08-371X  Ex ia IIC T6 (Ta = -50°C to +40°C) T5 (Ta = -50°C to +55°C) T4 (Ta = -50°C to +85°C)	Z2	•	•	•
	Flameproof, Zone 1	SAEx S/08-372X  Ex d IIC T6 (Ta = -50°C to +80°C) T5 (Ta = -50°C to +85°C) Ex tD A21 T80°C (Ta = 80°C) T95°C (Ta = 85°C) Enclosure rated IP 66/67	ZD	•	•	•
	Intrinsically Safe Zone 0/1 and Flameproof, Zone 1	SAEx S/08-371X  Ex ia IIC T6 (Ta = -50°C to +40°C) T5 (Ta = -50°C to +55°C) T4 (Ta = -50°C to +85°C) ----- SAEx S/08-372X  Ex d IIC T6 (Ta = -50°C to +80°C) T5 (Ta = -50°C to +85°C) Ex tD A21 T80°C (Ta = 80°C) T95°C (Ta = 85°C) Enclosure rated IP 66/67	ZA	•	•	•
IECEX	Flameproof, Zone 1 (with IS transmitter)	Ex d IIC; T6 (Ta = -50 to +80°C) T5 (Ta = -50 to +85°C) Ex tD A21 IP6X T80°C (Ta = -50 to +80°C) Ex tD A21 IP6X T95°C (Ta = -50 to +85°C)	CB	•	•	•
	Intrinsically Safe Zone 0/1	Ex ia IIC; T6 (Ta = -50 to +40°C) T5 (Ta = -50 to +55°C) T4 (Ta = -50 to +85°C)	CS	•	•	•
INMETRO (Brazil)	Flameproof, Zone 1	BR Ex d IIC T6, T5, T4 Enclosure rated IP 66/67	6D	p		
	Intrinsically Safe, Zone 0/1	BR Ex ia IIC T6, T5, T4 (Module)	6S	b	b	b

(6) The module itself is rated intrinsically safe, IP20. An appropriately rated enclosure is required for Outdoor and Dust locations.

* Module must be installed in IP54 or better housing for Zone 2 approval validity.

** The user must determine the type of protection required for installation of the equipment. The user shall then check the box () adjacent to the type of protection used on the equipment certification label. Once a type of protection has been checked on the label, the equipment shall not be reinstalled using any of the other certification type.

RESTRICTIONS

Restriction Letter	Available Only With		Not Available With	
	Table	Selection	Table	Selection
b			Key No.	STT25T
d	Key No.	STT25S		
e			VII	3D
f	II	ENO, TNO,		
g	Key No.	STT25H, STT25M		See Note 6
h	Key No.	STT25H, STT25T, STT25M,STT25S		
i	Key No.	STT25M, STT25D		
p	II	E __, T __		

Notes: (6) The module itself is rated intrinsically safe, IP20. An appropriately rated enclosure is required for Outdoor and Dust locations.
 See 13:STT-9 or Operator's Manual EN11-6190 for part numbers.
 See 13:STT-OE pages for Order Entry Information including tagging, transmitter configuration, manuals, certificates, drawings and SPINS.
 To request a quotation for a non-published "special", fax RFQ to Marketing Applications at (1) 602 313-6155.

Ordering Example: STT25M-0-000-000-000-000-00-1C



Honeywell

AUTHORIZED DISTRIBUTOR

De Gidts & Feldman BV
The Netherlands
w w w . d g f g . n l



De Gidts & Feldman

INSTRUMENTATION & FILTRATION

For More Information

Learn more about how Honeywell's STT3000 Smart Temperature Transmitters can increase performance, reduce downtime and decrease configuration costs, visit our website www.honeywellprocess.com or contact your Honeywell account manager.

Honeywell Process Solutions

2500 W. Union Hills Dr.
Phoenix, AZ 85027
Tel: 877.466.3993 or 602.313.6665

www.honeywellprocess.com

EN0I-6031_Rev.1
March 2010
© 2008-10 Honeywell International Inc.

The Honeywell logo is displayed in a bold, red, sans-serif font.